



# ***Guntlin Elektronik AG***

Produkte & Preise/Produits & prix/Prodotti & prezzi



BRÜGLISTRASSE 11B  
CH-8852 ALTENDORF SZ  
TEL. +41 55 442 35 45  
FAX +41 55 442 61 62  
INFO@GUNTLIN.CH  
WWW.GUNTLIN.CH

**Barkan**   
a better point of view™

**exelium**

AUDIORAQ®

**AUDIOLAB**®



 **AGFA**PHOTO

**4 - 16**

Wandhalterungen/Suppoorts muraux/  
Supporti a parete

4

**Barkan**  
a better point of view™

10

**eXelium**

15

**M**

16

**AUDIORAQ®**

**14**

iPod & Tablet Zubehör/Accessoires/Accessori

**eXelium**

**17 - 26**

Möbel/Meubles/Mobili

17

**AUDIORAQ®**

**24 - 25**

Linea

24

**AUDIORAQ®**

**27 - 33**

Cable Management

27

**AUDIOLAB®**

33

**M**

**34**

Batterien/Piles/Batterie

**AGFA PHOTO**

VESA 200x200 – Small < 37"/94 cm LIFETIME WARRANTY



**E20 Fixed**  
VESA & Non VESA up to 200 x 200 mm  
Weight up to: 40 kg  
Distance from wall: 2.8 cm  
Color: Metallic Black

CHF 29.–



Self Assembly	Fall Proof	Lateral Adjustment	Height Adjustment	Built in Level	Quick Connect
AS EASY AS 1-2-3					



**21H Tilt**  
VESA & Non VESA up to 200 x 200 mm  
Weight up to: 40 kg  
Distance from wall: 7.5 cm  
Color: Metallic Black  
Tilt 15°

CHF 69.–



Self Assembly	Fall Proof	Easy Tilt	Lateral Adjustment	Built in Level	Quick Connect
AS EASY AS 1-2-3					

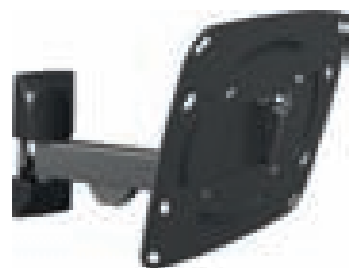

**E230 3 Movement**  
VESA up to 200 x 200 mm  
Weight up to: 25 kg  
Distance from wall: Min. 5 cm / Max. 25.4 cm  
Color: Metallic Black  
Tilt 15°

CHF 85.–



Self Assembly	Fall Proof	Screen Leveling	Low Profile	Easy Tilt	Cable Management
AS EASY AS 1-2-3					



**E240 4 Movement**  
VESA up to 200 x 200 mm  
Weight up to: 25 kg  
Distance from wall: Min. 5.1 cm / Max. 43.7 cm  
Color: Metallic Black  
Tilt 15°

CHF 99.–



Self Assembly	Fall Proof	Screen Leveling	Low Profile	Easy Tilt	Cable Management
AS EASY AS 1-2-3					

VESA 400x400 – Medium < 56"/142 cm



**E30 Fixed**  
VESA & Non VESA up to 400 x 400 mm  
Weight up to: 50 kg  
Distance from wall: 3.1 cm  
Color: Metallic Black

CHF 55.–



Self Assembly	Fall Proof	Lateral Adjustment	Height Adjustment	Built in Level	Quick Connect
AS EASY AS 1-2-3					

VESA 400x400 – Medium < 56"/142 cm LIFETIME WARRANTY



**31H Tilt**  
VESA & Non VESA up to 400 x 400 mm  
Weight up to: 50 kg  
Distance from wall: 7.5 cm  
Color: Metallic Black  
Tilt 15°

CHF 88.–



Self Assembly	Fall Proof	Easy Tilt	Lateral Adjustment	Built in Level	Quick Connect
AS EASY AS 1-2-3					

VESA 400x400 – Medium < 56"/142 cm LIFETIME WARRANTY



**E320 2 Movement**  
VESA & Non VESA up to 400 x 400 mm  
Weight up to: 30 kg  
Distance from wall: 10.1 cm  
Color: Metallic Black  
Tilt 15°

CHF 88.–



Self Assembly	Fall Proof	Screen Leveling	Easy Tilt		
AS EASY AS 1-2-3					

VESA 400x400 – Medium < 56"/142 cm LIFETIME WARRANTY



**E330 3 Movement**  
VESA & Non VESA up to 400 x 400 mm  
Weight up to: 30 kg  
Distance from wall: Min. 6.2 cm / Max. 26.2 cm  
Color: Metallic Black  
Tilt 15°

CHF 98.–



Self Assembly	Fall Proof	Screen Leveling	Easy Tilt	Cable Management	
AS EASY AS 1-2-3					

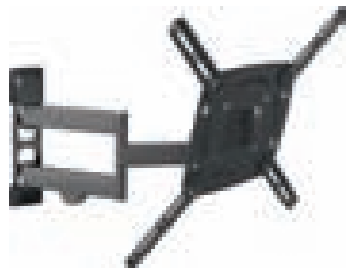

**E340 4 Movement**  
VESA & Non VESA up to 400 x 400 mm  
Weight up to: 30 kg  
Distance from wall: Min. 6.9 cm / Max. 44 cm  
Color: Metallic Black  
Tilt 15°

CHF 139.–



Self Assembly	Fall Proof	Screen Leveling	Easy Tilt	Cable Management	
AS EASY AS 1-2-3					

VESA 400x400 – Ceiling Mount < 56"/142 cm LIFETIME WARRANTY



**35 Ceiling 3 Movement**  
VESA & Non VESA up to 400 x 400 mm  
Add Adaptor 38 for up to 600 x 400 mm  
Weight up to: 30 kg  
Distance from wall: Min. 49 cm / Max. 77 cm  
Color: Silver & Metallic Black  
Tilt 15°

CHF 225.–

**38 Mount Adaptor Extension**  
For back screen mounting holes up to 600 x 400 mm  
Includes 4 units  
Color: Metallic Black

CHF 29.–

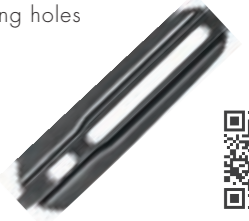

Self Assembly	Fall Proof	Screen Leveling	Touch Tilt	Cable Management	Quick Connect	Telescopic Adjustment
AS EASY AS 1-2-3						

VESA 600x400 – Medium < 65"/165 cm LIFETIME WARRANTY

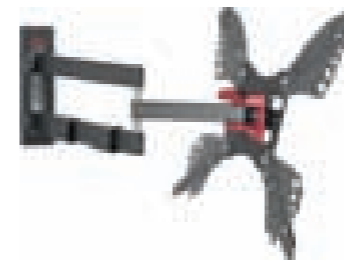

«« Extremely Extendable »»

**34L 4 Movement**  
VESA & Non VESA up to 600 x 400 mm  
Weight up to: 40 kg  
Distance from wall: Min. 5.9 cm / Max. 64.2 cm  
Color: Metallic Black  
Tilt 15°

CHF 229.–



Self Assembly	Fall Proof	Screen Leveling	Low Profile	Easy Tilt	Cable Binder
AS EASY AS 1-2-3					



**34F 4 Movement**  
VESA & Non VESA up to 600 x 400 mm  
Weight up to: 35 kg  
Distance from wall: Min. 3.7 cm / Max. 53.7 cm  
Color: Metallic Black  
Tilt 20°

CHF 199.–



Self Assembly	Fall Proof	Screen Leveling	Low Profile	Easy Tilt	Cable Binder
AS EASY AS 1-2-3					

## Wall mounts

VESA 800x400 – Large < 80"/203 cm LIFETIME WARRANTY

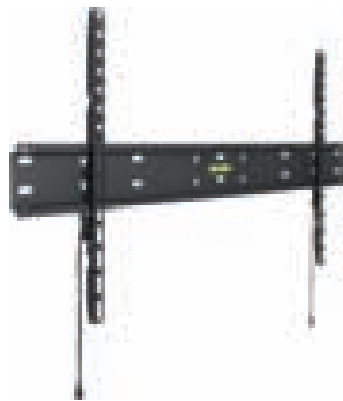

**E40 Fixed**  
VESA & Non VESA up to 800 x 400 mm  
Weight up to: 60 kg  
Distance from wall: 3.1 cm  
Color: Metallic Black

CHF 75.–



Self Assembly	Fall Proof	Lateral Adjustment	Height Adjustment	Built in Level	Quick Connect
AS EASY AS 1-2-3					



**41H Tilt**  
VESA & Non VESA up to 800 x 400 mm  
Weight up to: 60 kg  
Distance from wall: 7.5 cm  
Color: Metallic Black  
Tilt 15°

CHF 99.–



Self Assembly	Fall Proof	Easy Tilt	Lateral Adjustment	Built in Level	Quick Connect
AS EASY AS 1-2-3					

VESA 800x400 – Large < 80"/203 cm LIFETIME WARRANTY



**44F 4 Movement (Rotate, Fold, Swivel & Tilt)**  
VESA & Non VESA up to 600 x 400 mm  
Weight up to: 50 kg  
Distance from wall: Min. 5.7 cm / Max. 62 cm  
Color: Metallic Black  
Tilt 10°

CHF 239.–



◀◀ Extremely Extendable ▶▶

Fall Proof	Screen Leveling	Very Low Profile	Touch & Tilt	Cable Management	Quick Connect

## Projector Mounts



**90 Standard Projector Ceiling Mount**  
Weight up to: 11 kg  
Distance from wall: 11.5 cm  
Color: Silver  
Tilt 30°

CHF 118.–



Self Assembly	Fall Proof	Easy Tilt	Quick Connect
AS EASY AS 1-2-3			

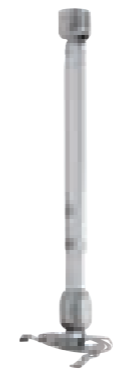

**91 Telescopic Projector Ceiling Mount**  
Weight up to: 11 kg  
Distance from wall: Min. 56.5 cm / Max. 81 cm  
Color: Silver  
Tilt 30°

CHF 198.–



Self Assembly	Fall Proof	Easy Tilt	Quick Connect	Cable Management	Telescopic Adjustment
AS EASY AS 1-2-3					

X-FLAT

10.S

CHF 45.-

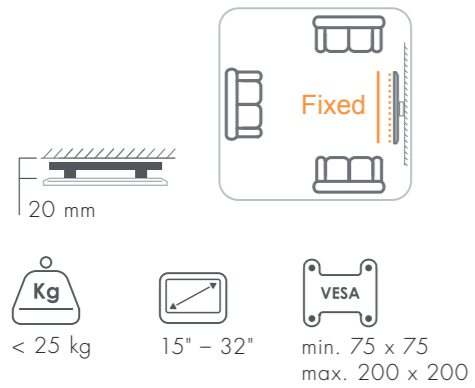

X-FLAT

25.XL

CHF 249.-

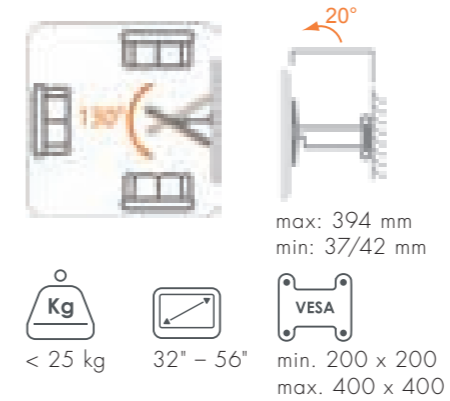

10.L

CHF 89.-

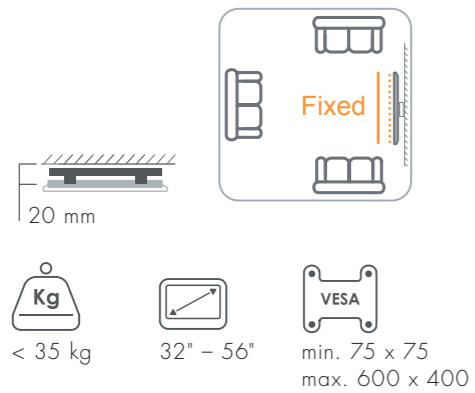

25.S

CHF 89.-

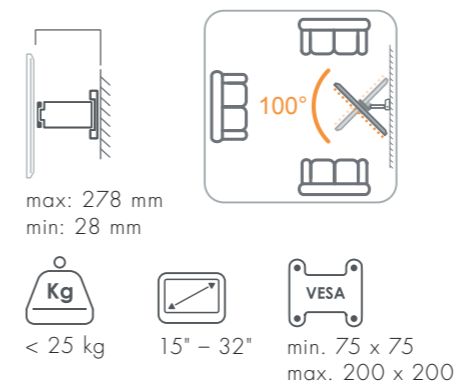

20.L

CHF 198.-

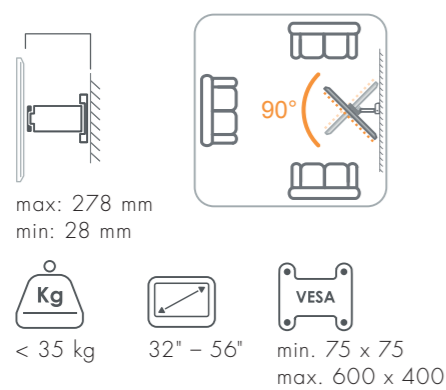

35.S

CHF 129.-

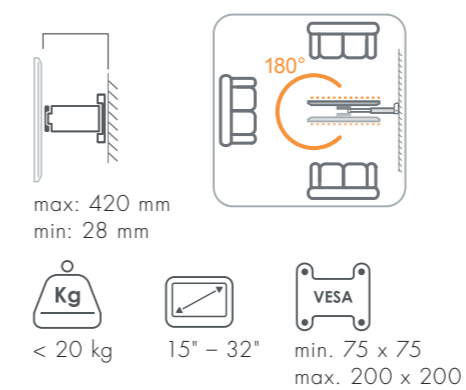

i-FLAT

i25

CHF 175.-

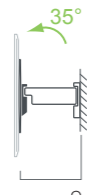
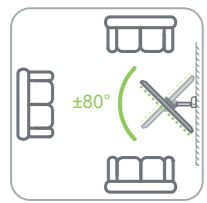

max: 243 mm  
min: 35 mm



< 18 kg



26" - 46"



min. 75 x 75  
max. 400 x 400



i35

CHF 198.-

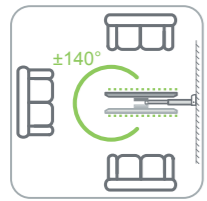

max: 410 mm  
min: 35 mm



< 16 kg



26" - 46"



min. 75 x 75  
max. 400 x 400



SLIDE

21.XL

CHF 490.-

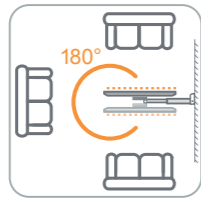
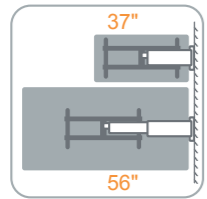

**SLIDE**  
PATENTED SLIDE SYSTEM



< 25 kg



37" - 56"



min. 200 x 200  
max. 400 x 400

max: 650 mm  
min: 34/39 mm



neo FLAT

neo10

CHF 82.-



< 30 Kg



19" - 32"



min. 75x75  
min. 200x200



+/- 5°



tilt +10/-15°



+70/-70°



min: 35 mm



max: 240 mm



neo15

CHF 129.-



< 30 Kg



32" - 55"



min. 75x75  
min. 400x400



+/- 5°



tilt +10/-15°



+45/-45°



min: 35 mm



max: 240 mm



neo25

CHF 149.-



< 30 Kg



32" - 55"



min. 75x75  
min. 400x400



+/- 5°



tilt +10/-15°



+70/-70°



min: 35 mm



max: 360 mm



UP'

Ar.-Nr.	Bezeichnung Désignation Definizione	Preis Prix Prezzo
UP150	Accessories for tablet-Universal 7" - 12" white/black univers	CHF 46.-
UP250	Accessories for tablet-Universal car mount-wall base 7" - 12" white/black univers	CHF 89.-
UP450	Accessories for tablet-Universal wall mount with sliding arm 7" - 12" white/black univers	CHF 79.-
UP550	Accessories for tablet-Universal wall mount with flexible arm 7" - 12" white/black univers	CHF 109.-



**M VESA Wallmount III**

For screen size: 15-40"  
Universal & VESA standard: 50x50 75x75 100x100  
200x100 200x200 mm  
Size in mm: 260x220x17  
Colour: Black & Silver  
Max load: 30 kg  
Warranty: 5 years

CHF 49.-



**M Universal Tilt Wallmount Black Medium**

For screen size: 32-47"  
Universal & VESA standard: 200x100 200x200  
300x200 300x300 400x200 400x400 mm  
Distance to wall: (min-max) 45 -113mm  
Colour: Black  
Max load: 75 kg  
Tilt 10°  
Warranty: 5 years

CHF 85.-



**M VESA Super Slim Tilt & Turn Plus HD**

For screen size: 42-84"  
Universal & VESA standard: 100x100 200x100  
200x200 300x300 300x200 400x200 400x400  
Size in mm: 595\*294\*48-449 (W\*H\*D)  
Distance to wall: VESA 100 / 200 / 300: 49mm  
Distance to wall with extender: VESA 400: 59mm  
Weight: 10 kg  
Colour: Black  
Max load: 65 kg  
Tilt -2°~+7°  
Warranty: 5 years  
For VESA 600x400 600x300 600x200: Combine  
with optional M Extender Kit Tilt & Turn

CHF 329.-

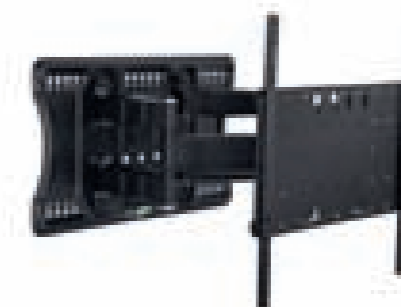

Option: Curved TV-Adapter CHF 29.-





## Wall mounts

### M Universal Wallmount Super Slim Silver Small

For screen size: 26–32"  
 Universal: Max holepattern 450mm wide and 2000 mm high  
 VESA standard: 200x100 200x200 300x300 or 400x400 mm  
 Colour: Silver  
 Max load: 55 kg  
 Warranty: 5 years

CHF 125.—

### M Universal Wallmount Super Slim Silver Medium

For screen size: 32–46"  
 Universal: Max holepattern 700 mm wide and 2000 mm high  
 VESA standard: 200x200 mm, 300x300 mm, 400x400 mm or 600x400 mm  
 Colour: Silver  
 Max load: 55 kg  
 Warranty: 5 years

CHF 135.—

### M Universal Wallmount Super Slim Silver Large

For screen size: 46–63"  
 Universal: Max holepattern 1000 mm wide and 2000 mm high  
 VESA standard: 300x300 mm, 400x400 mm, 600x400 mm, 800x600 mm or 900x600 mm  
 Colour: Silver  
 Max load: 55 kg  
 Warranty: 5 years

CHF 145.—



## AUDIORAQ®

### Wallmount

VESA 400 x 400  
 Max. 40 kg  
 Max. 400 mm Min. 50mm

AWH 4040-SI  
 CHF 99.—

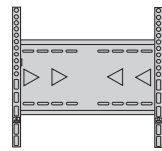

Silber  
 Argent  
 Argento

AWH 4040-SW  
 CHF 99.—

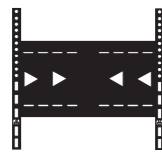

Schwarz  
 Noir  
 Nero

AWH 4040-WE  
 CHF 99.—

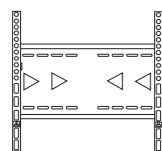

Weiss  
 Blanc  
 Bianco



## AUDIORAQ®

## Möbel/Meubles/Mobili

### Lugano



Farben:  
 Weiss  
 Schwarz  
 Hickory/Esche

CHF 769.— unmont.

Couleurs:  
 blanc  
 noir  
 frêne

CHF 769.— unmont.

Colori:  
 bianco  
 nero  
 frassino

CHF 769.— unmont.



### Sierre



Farben:  
 Weiss  
 Schwarz

CHF 699.— mont.

Couleurs:  
 blanc  
 noir

CHF 699.— mont.

Colori:  
 bianco  
 nero

CHF 699.— mont.

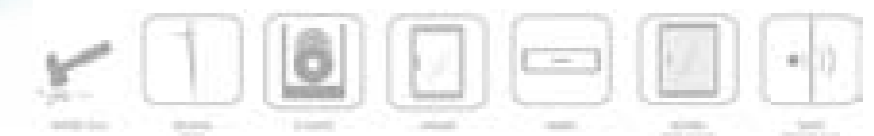
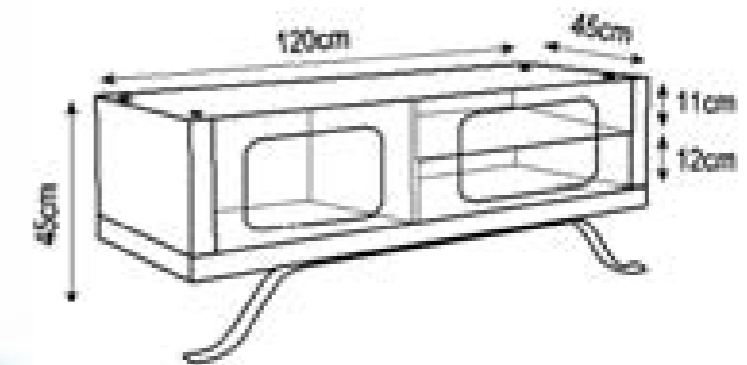

Eco

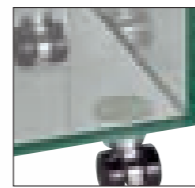

Eco richtet sich an preisbewusste Anwender, die nicht auf Leichtigkeit und Eleganz verzichten wollen. Optimale Abmessungen und 10 mm-Glas machen es möglich.

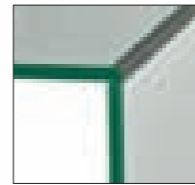

Eco s'adresse à des utilisateurs conscients des prix qui ne sont pas prêts à renoncer à la facilité et à l'élégance. Les dimensions optimales et le verre 10 mm le rendent possible.



Eco si rivolge ad utenti esperti, che non vogliono rinunciare alla leggerezza ed all'eleganza. Ciò è reso possibile dalle misure ottimali e dal spessore di 10 mm.

Eco 750-40 KG

KG  
Klarglas  
Verre transparent  
Vetro trasparente



RG  
Rauchglas  
Verre fumé  
Vetro fumo

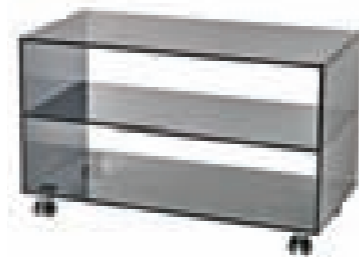

WS  
Weiss (Ral 9003)  
Blache (Ral 9003)  
Bianco (Ral 9003)

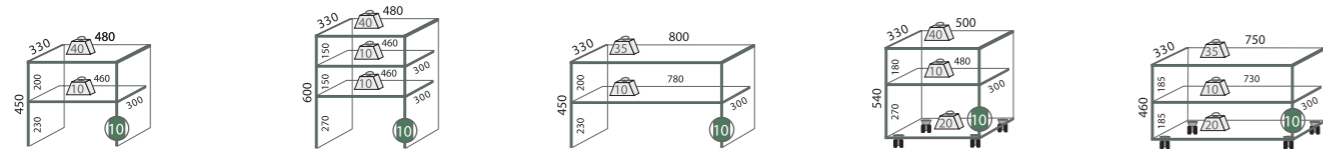

Eco 480-45 KG CHF 295.—	Eco 480-60 KG CHF 395.—	Eco 800-45 KG CHF 425.—	Eco 500-48 KG CHF 525.—	Eco 750-40 KG CHF 595.—
Eco 480-45 RG CHF 350.—	Eco 480-60 RG CHF 450.—	Eco 800-45 RG CHF 495.—	Eco 500-48 RG CHF 590.—	Eco 750-40 RG CHF 675.—
			Eco 500-48 WS* CHF 790.—	Eco 750-40 WS* CHF 890.—

Max. Belastung 40 kg/Charge max. 40 kg/Carico massimo 40 kg

\*Rückwand geschlossen/Derrière fermé/Posteriore chiuso

Canto AV-Console



Mit diesen AV-Konsolen schaffen Sie mit «Leichtigkeit» Platz für Ihre Zusatzgeräte. 12 mm-Glas mit Facettenschliff.

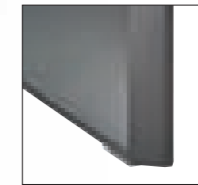

Cette console AV vous permet avec facilité de faire de la place pour vos appareils accessoires. Verre de 12 mm à structure de facettes.



Con queste console Audio-Video si ottengono maggiore «leggerezza» e spazio per i propri apparecchi supplementari. Con vetro intagliato e spesso 12 mm.

KG  
Klarglas  
Verre transparent  
Vetro trasparente



RG  
Rauchglas  
Verre fumé  
Vetro fumo



Canto 650-11 RG

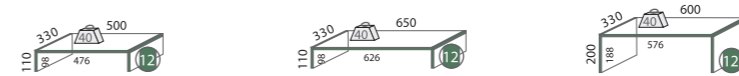

Canto 500-11 KG CHF 245.—	Canto 650-11 KG CHF 260.—	Canto 600-20 KG CHF 270.—		
Canto 500-11 RG CHF 260.—	Canto 650-11 RG CHF 275.—	Canto 600-20 RG CHF 295.—		

Max. Belastung 40 kg/Charge max. 40 kg/Carico massimo 40 kg

Sonderausführung/Réalisation spéciale/Esecuzione speciale

Wünsche in Glas? Wir erfüllen sie gerne! Zusammen mit Spezialisten setzen wir Ihre Visionen um. Aufpreis für Massänderungen +25%

Envies de verre? Nous les réalisons avec plaisir! Nous concrétisons vos visions avec l'aide de spécialistes. Surtaxe pour modifications de mesure env. +25%

Saremo lieti di soddisfare ogni vostra richiesta di esecuzione in vetro! I nostri specialisti trasformano i vostri sogni in realtà. Supplemento per cambiamenti di misura appr. +25%

Canto



Canto 1050-45 RG

Schlicht, einfach und geradlinig. Wählbar in verschiedenen Breiten. 12 mm-Glas mit Facettenschliff.

Sobre, simple et rectiligne. Diverses largeurs à choix. Verre de 12 mm à structure de facettes.

Sobrio, semplice e lineare. Disponibile in diverse larghezze. Con vetro intagliato e spesso 12 mm.

KG  
Klarglas  
Verre transparent  
Vetro trasparente

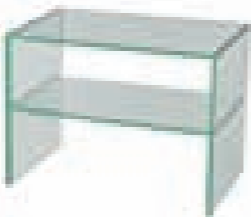

RG  
Rauchglas  
Verre fumé  
Vetro fumo

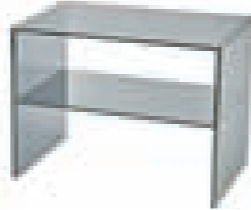

OW  
Klarglas Optiwhite  
Verre transp. Optiwhite  
Vetro trasp. Optiwhite

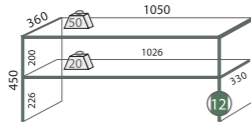
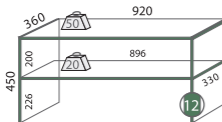
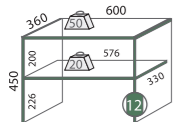
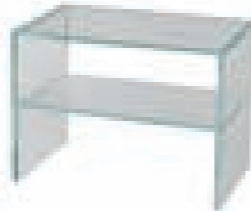

Canto 600-45 KG CHF 460.—	Canto 920-45 KG CHF 520.—	Canto 1050-45 KG CHF 550.—	Zubehör Accessoires/Accessori
Canto 600-45 RG CHF 560.—	Canto 920-45 RG CHF 590.—	Canto 1050-45 RG CHF 630.—	KF 3040 CHF 69.—
Canto 600-45 OW CHF 560.—	Canto 920-45 OW CHF 590.—	Canto 1050-45 OW CHF 630.—	
Max. Belastung 60 kg/Charge max. 60 kg/Carico massimo 60 kg			

Rettangolo

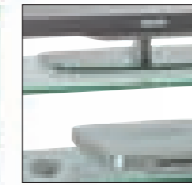
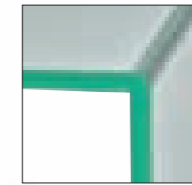
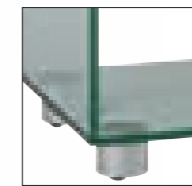

Rettangolo 1000-40 KG

Rettangolo steht für modernes und innovatives Design. Es präsentiert Ihre Anlage optimal. Verdeckte Rollen.

Rettangolo, c'est une ligne moderne et innovatrice qui présente votre dispositif de manière optimale. Roulettes dissimulées.

Rettangolo, una linea moderna e innovativa che presenta il suo impianto in modo ottimale. Rotelle coperte.

KG  
Klarglas  
Verre transparent  
Vetro trasparente

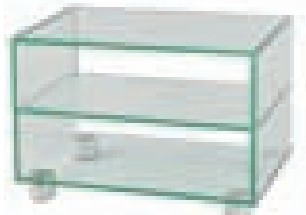

RG  
Rauchglas  
Verre fumé  
Vetro fumo

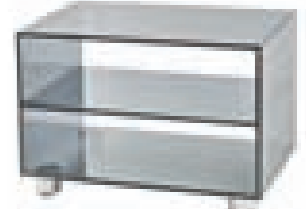

OW  
Klarglas Optiwhite  
Verre transp. Optiwhite  
Vetro trasp. Optiwhite



WS  
Weiss (Ral 9003)  
Blache (Ral 9003)  
Bianco (Ral 9003)

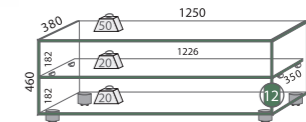
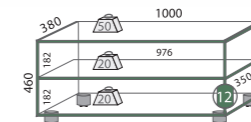
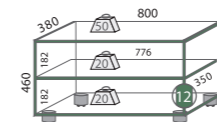
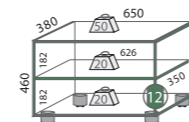

Rettangolo 650-40 KG CHF 780.—	Rettangolo 800-40 KG CHF 795.—	Rettangolo 1000-40 KG CHF 895.—	Rettangolo 1250-40 KG CHF 1050.—	Zubehör Accessoires/Accessori
Rettangolo 650-40 RG CHF 895.—	Rettangolo 800-40 RG CHF 950.—	Rettangolo 1000-40 RG CHF 995.—	Rettangolo 1250-40 RG CHF 1195.—	KF 3036 CHF 69.—
Rettangolo 650-40 OW CHF 895.—	Rettangolo 800-40 OW CHF 950.—	Rettangolo 1000-40 OW CHF 995.—	Rettangolo 1250-40 OW CHF 1195.—	
		Rettangolo 1000-40 WS* CHF 1990.—		

Max. Belastung 60 kg/Charge max. 60 kg/Carico massimo 60 kg

\*Rückwand geschlossen plus zwei Fronttüren/Derrière fermé plus front avec deux portes/Posteriore chiuso più frontale con due porte

Sonderausführung/Réalisation spéciale/Esecuzione speciale

Wünsche in Glas? Wir erfüllen sie gerne! Zusammen mit Spezialisten setzen wir Ihre Visionen um. Aufpreis für Massänderungen +25%

Envies de verre? Nous les réalisons avec plaisir! Nous concrétisons vos visions avec l'aide de spécialistes. Surtaxe pour modifications de mesure env. +25%

Saremo lieti di soddisfare ogni vostra richiesta di esecuzione in vetro! I nostri specialisti trasformano i vostri sogni in realtà. Supplemento per cambiamenti di misura appr. +25%

Sonderausführung/Réalisation spéciale/Esecuzione speciale

Wünsche in Glas? Wir erfüllen sie gerne! Zusammen mit Spezialisten setzen wir Ihre Visionen um. Aufpreis für Massänderungen +25%

Envies de verre? Nous les réalisons avec plaisir! Nous concrétisons vos visions avec l'aide de spécialistes. Surtaxe pour modifications de mesure env. +25%

Saremo lieti di soddisfare ogni vostra richiesta di esecuzione in vetro! I nostri specialisti trasformano i vostri sogni in realtà. Supplemento per cambiamenti di misura appr. +25%

Cubo

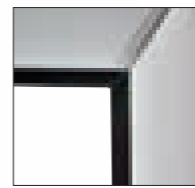

Sind Sie gerne auf Augenhöhe? Dann sind diese Modelle genau richtig für Sie. Einfach Glas klar. Verdeckte Rollen.

Aimez-vous bien être à la hauteur des yeux? Alors, ces modèles sont parfaits pour vous. Tout simplement clair comme du verre. Roulettes dissimulées.

Ami le cose ad altezza d'occhio? Allora questi modelli sono proprio ciò che fa per te. Semplicemente chiari come il vetro. Rotelle coperte.

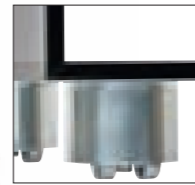

**KG**  
Klarglas  
Verre transparent  
Vetro trasparente



**RG**  
Rauchglas  
Verre fumé  
Vetro fumo



**OW**  
Klarglas Optiwhite  
Verre transp. Optiwhite  
Vetro trasp. Optiwhite



Cubo 1120-25 RG

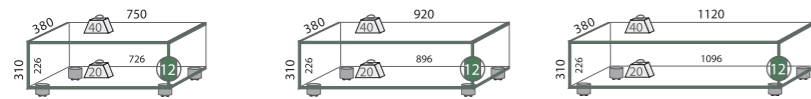

Cubo 750-25 KG CHF 725.-	Cubo 920-25 KG CHF 770.-	Cubo 1120-25 KG CHF 795.-		
Cubo 750-25 RG CHF 825.-	Cubo 920-25 RG CHF 870.-	Cubo 1120-25 RG CHF 895.-		
Cubo 750-25 OW CHF 825.-	Cubo 920-25 OW CHF 870.-	Cubo 1120-25 OW CHF 895.-		

Max. Belastung 60 kg/Charge max. 60 kg/Carico massimo 60 kg

Sonderausführung/Réalisation spéciale/Esecuzione speciale

Wünsche in Glas? Wir erfüllen sie gerne! Zusammen mit Spezialisten setzen wir Ihre Visionen um. Aufpreis für Massänderungen +25%

Envies de verre? Nous les réalisons avec plaisir! Nous concrétisons vos visions avec l'aide de spécialistes. Surtaxe pour modifications de mesure env. +25%

Saremo lieti di soddisfare ogni vostra richiesta di esecuzione in vetro! I nostri specialisti trasformano i vostri sogni in realtà. Supplemento per cambiamenti di misura appr. +25%

Economic-Line



Sehr preiswertes und praktisches AV-Möbel. Das schwarz lackierte Glas verbunden mit den verchromten Rohren macht es leicht und elegant zugleich.

Meuble audio/vidéo à prix avantageux et très pratique. Léger et élégant à la fois grâce à la combinaison de verre laqué noir et de tubes chromés.

Mobile audio/video molto pratico e conveniente. Il vetro laccato nero abbinato ai tubi cromati lo rende allo stesso tempo leggero ed elegante.



**KG**  
Klarglas  
Verre transparent  
Vetro trasparente



**RG**  
Rauchglas  
Verre fumé  
Vetro fumo

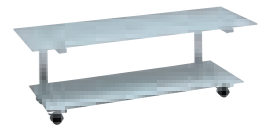

**SG**  
Schwarzglas  
Verre noir  
Vetro nero



EL 10553 KG/CH

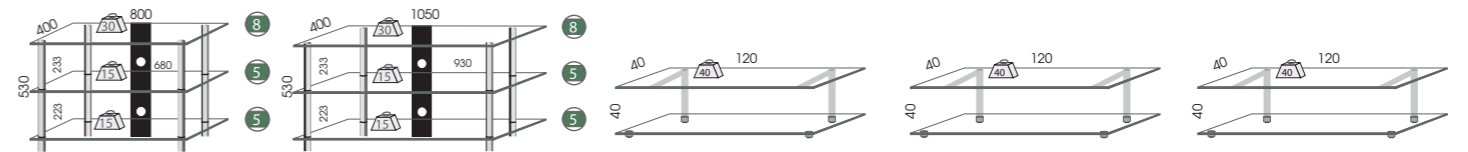

EL 8053 KG/CH CHF 185.-	EL 10553 KG/CH CHF 235.-	ELU 12040 KG/SI CHF 219.-	ELU 12040 RG/CH CHF 249.-	ELU 12040 SG/GR CHF 259.-
EL 8053 SG/CH CHF 195.-	EL 10553 SG/CH CHF 245.-			

Max. Belastung EL: 50 kg und ELU: 40 kg/Charge max. EL: 50 kg et ELU: 40 kg/Carico massimo EL: 50 kg e ELU: 40 kg

Handyspring



**Handyspring**  
TV Fuss  
höhenverstellbar mittels Gasfeder  
Silber, Schwarz und Weiss  
Max. Tragkraft 40 kg  
Min. 32" – Max. 50"  
140 cm – 170 cm  
Fuss: 60 x 60 cm  
Rollen verdeckt

CHF 499.-

**Handyspring**  
Ped télé  
Réglable en hauteur avec le vérin à gaz  
Argent, Noir et Blanc  
Max. capacité de charge 40 kg  
Min. 32" – Max. 50"  
140 cm – 170 cm  
Pied: 60 x 60 cm  
Roules caché

CHF 499.-

**Handyspring**  
Piede per TV  
con molla a gas per altezza variabile  
Argento, nero e bianco  
Portata max. 40 kg  
Min. 32" – Max. 50"  
140 cm – 170 cm  
Piede: 60 x 60 cm  
Rotolo coperto

CHF 499.-

Linea

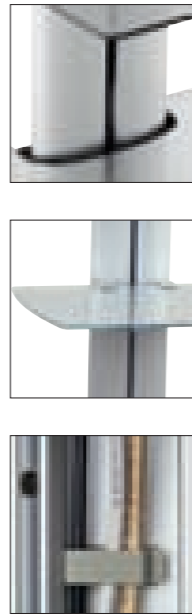

Linea ist dank Qualität, Individualität, Funktionalität und Design zum Klassiker geworden. Es eignet sich als Wand- oder Standsystem. Die Fachböden und der TV-Halter sind stufenlos höhenverstellbar. Die Kabelführung erfolgt unter dem Aluprofil. Besonders geschätzt wird die Drehbarkeit des Systems.

Grâce à sa qualité, son individualité, sa fonctionnalité et son design, Linea est devenu un modèle classique. Il peut être utilisé en tant que système mural ou indépendant. La hauteur des tablettes et du support TV peut être réglée en continu. Le guidage des câbles est assuré par le profilé en aluminium. Les utilisateurs apprécient surtout la possibilité d'orienter le système.

Grazie alla sua qualità, al suo accento individuale, al design e alla funzionalità, Linea è diventato un classico. È adatta sia come sistema a parete, sia come sistema assestante. I ripiani ed il supporto per il televisore sono regolabili in altezza. Il condotto dei cavi è realizzato attraverso un profilo in alluminio. Molto amata è la capacità di orientamento del sistema. Con attacchi per l'installazione alla parete.

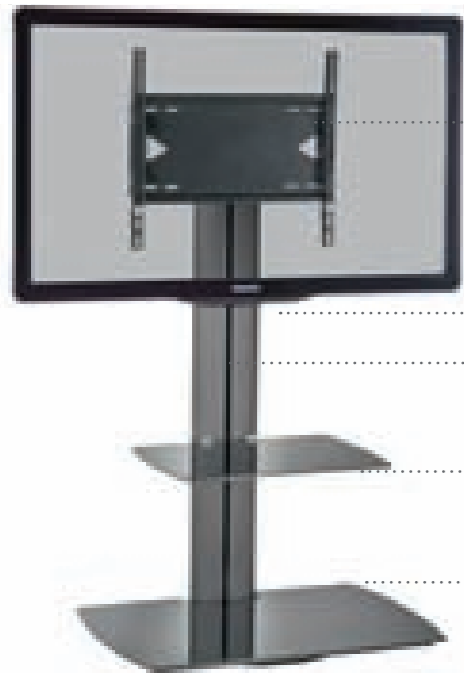

3 TV-Halterung  
Support TV  
Supporto per TV

1 Aluprofil in 3 Farben und 5 Längen  
Profilé alu en 3 coloris et 5 longueurs  
Profilo d'alluminio in 3 colori e 5 lunghezze

5 Soundbarhalterung  
Support Soundbar  
Supporto Soundbar

4 Fachböden höhenverstellbar  
Tablettes réglables en hauteur  
Ripiani regolabili in altezza

2 Fuss in 2 Grössen und 3 Farben  
Pied en 2 formats et 3 coloris  
Piede in 2 grandezze e 3 colori

2.1 Wahlweise mit Drehring, Rollen oder Gummipoppen  
Au choix avec couronne pivotante, roulettes ou bouchons en caoutchouc  
A scelta con anello girevole, rotelle o tappi in gomma

Farben/Couleur/Colori:

SI = Silber  
argent/argento

SW = Schwarz  
noir/nero

WE = Weiss  
blanc/blanco

GM\* = Grau metallic  
Gris métallisé/Grigio metallizzato

SW\* = Schwarzglas  
Verre noir/Vetro nero

WG\* = Weissglas  
Verre blanc/Vetro bianco

KG = Klarglas  
Verre transparent/Vetro trasparente

\* Glas einseitig lackiert  
\* Verre sur une face  
\* Vetro unilaterale

1 Aluprofil/Profil d'aluminium/Profilo d'alluminio

	43 cm	80 cm	110 cm	140 cm	200 cm
Farben/Couleur/Colori:	LPR 430	LPR 800	LPR 1100	LPR 1400	LPR 2000
SI Silber/argent/argento*	225.-	270.-	350.-	420.-	570.-
SW Schwarz/noir/nero*	285.-	365.-	445.-	540.-	690.-
WE Weiss/blanc/blanco**	380.-	495.-	585.-	695.-	790.-

\* Eloxiert/anodise/anodizzato  
\*\* Lackiert/verni/vernice

Wandmontage  
Montage mural  
Montaggio a parete



Alle Profile auch für Wandmontage geeignet  
Tous les profils aussi pour montage mural  
Tutti i profili adatti per fissaggio parete

2 Fuss/Pied/Piedi

< 37" Max. 40 kg	520	520	520
	LFU 5234 GM CHF 420.-	LFU 5234 SW CHF 420.-	LFU 5234 WG CHF 420.-
> 40" Max. 50 kg	700	700	700
	LFU 7048 GM CHF 580.-	LFU 7048 SW CHF 580.-	LFU 7048 WG CHF 580.-

2.1 Option/Opzione

Drehring Couronne pivotante Anello girevole	Rollen Roulettes Rotelle
DR 306 AL CHF 75.-	LRO 4 SW/W CHF 70.-
DR 450 AL CHF 175.-	LRO 5 SW/W CHF 85.-

3 TV-Halter/Support/Supporto

VESA 400 x 400 Max. 40 kg	Max. 400 Min. 50	Max. 400 Min. 50	Max. 400 Min. 50
	LTH 4040-SI CHF 135.-	LTH 4040-SW CHF 135.-	LTH 4040-WE CHF 135.-

Für/pour/per LOEWE

Max. 200 Min. 100
LAD 2010 SI CHF 79.-

4 Fachboden/Tablette/Ripiano

Max. 20 kg	480	480	480	480
	LFB 4835 GM CHF 250.-	LFB 4835 SW CHF 250.-	LFB 4835 WG CHF 250.-	LFB 4835 KG CHF 250.-

5 Soundbarhalterung/Support Soundbar/Supporto Soundbar

Soundbarhalterung – Universal (nur für LINEA) Support Soundbar – Universal (seulement pour LINEA) Supporto Soundbar – Universal (solamente per LINEA) 60x8 cm	Soundbarhalterung – Universal (allgemein Verwendbar) Support Soundbar – Universal (généralement utilisé) Supporto Soundbar – Universal (generalmente utilizzabile)
LSBH-60 SW CHF 89.00	SBH SW CHF 69.00

Tournable Glass / Wall Mounts

Glasdrehplatte/Plateau tournant en verre/Base routante in vetro

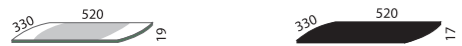
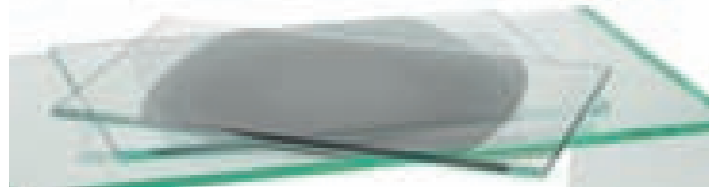

GP 3352 KG CHF 195.—	GP 3352 SG CHF 198.—	GP 3352 GM CHF 245.—
GP 3370 KG CHF 225.—		

Max. Belastung 60 kg KG = Klarglas/SG = Schwarzglas/GM = Grau metallic  
 Charge max. 60 kg KG = Verre transparent / SG = Verre noir / GM = Gris  
 Carico massimo 60 kg KG = Vetro trasparente / SG = Vetro nero / GM = Grigio metallizzato metallisé

Wandhalterungen/Support muraux/Supporti murali



WH 3529 SI/KG* CHF 185.—	WH 4340 SI/KG* CHF 195.—
-----------------------------	-----------------------------

\*Max. Belastung 12 kg  
 \*Charge max. 12 kg  
 \*Carico massimo 12 kg

Lautsprecherhalterungen/Support haut-parleur/Suporto attoparlante



**Punto**  
 silber und schwarz  
 2 Stück  
 Max. 25 kg  
**CHF 46.90**

**Punto**  
 argent et noir  
 2 pcs.  
 Max. 25 kg  
**CHF 46.90**

**Punto**  
 argento e nero  
 2 pezzi  
 Max. 25 kg  
**CHF 46.90**

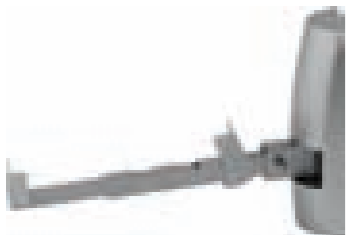

**Ulysses**  
 silber und schwarz  
 2 Stück  
 Max. 20 kg  
**CHF 49.90**

**Ulysses**  
 argent et noir  
 2 pcs.  
 Max. 25 kg  
**CHF 49.90**

**Ulysses**  
 argento e nero  
 2 pezzi  
 Max. 25 kg  
**CHF 49.90**

Cable Presentation

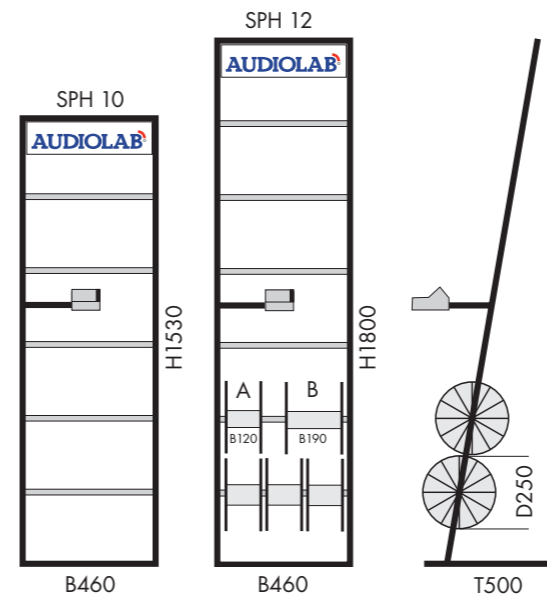

**Display Large**  
 SPH 10 (Max. 15 x Typ A)  
 SPH 12 (Max. 18 x Typ A)  
 – Messgerät  
 – Repräsentativ  
 – Funktionell  
 – Geringer Platzbedarf

Display RAL 7016 Anthrazit

**Display Large**  
 SPH 10 (Max. 15 x Typ A)  
 SPH 12 (Max. 18 x Typ A)  
 – Appareil de mesure  
 – Repräsentatif  
 – Fonctionnel  
 – Faible encombrement

Display RAL 7016 Anthracite

**Display Large**  
 SPH 10 (Max. 15 x Typ A)  
 SPH 12 (Max. 18 x Typ A)  
 – Apparto di misura  
 – Rappresentativo  
 – Funzionale  
 – Fabbisogno limitato di spazio

Display RAL 7016 Antracite

Cables

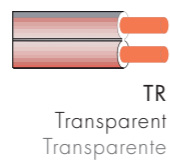
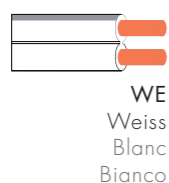
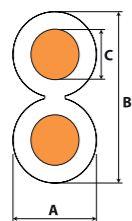

Audiolab® die beliebte und bewährte Kabelmarke für den Profi. Lautsprecherkabel mit Kennzeichnung und Metermarkierung. Alle Kabel werden auf einer stabilen Kunststoffspule geliefert.

Hiflex ligne sonne pour vous-même! Haute câble souple des enceintes avec étiquetage et le marquage. Tous les câbles sont fournis sur une bobine en plastique robuste.

La linea Hiflex suona per te! Cavo d'altoparlante altamente flessibile con etichettatura e la marcatura. Tutti i cavi sono forniti su una bobina di plastica robusta.

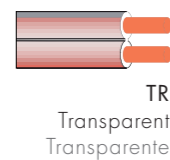
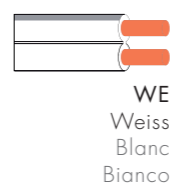
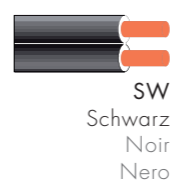
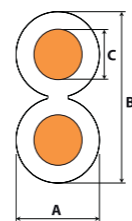

Audiolab® die beliebte und bewährte Kabelmarke für den Profi. Lautsprecherkabel mit Kennzeichnung und Metermarkierung. Alle Kabel werden auf einer stabilen Kunststoffspule geliefert.

Hiflex ligne sonne pour vous-même! Haute câble souple des enceintes avec étiquetage et le marquage. Tous les câbles sont fournis sur une bobine en plastique robuste.

La linea Hiflex suona per te! Cavo d'altoparlante altamente flessibile con etichettatura e la marcatura. Tutti i cavi sono forniti su una bobina di plastica robusta.



Bezeichnung Désignation Definizione	Grösse Dimension Taglio	Vermassung Mesurage Misurazione	Preis Prix Prezzo
<b>Budget-Line</b>	2 x 1.5 mm <sup>2</sup> / 2 x 30 x 0.25 mm	A=2.9 mm / B=6.4 mm / C=1.5 mm <sup>2</sup>	
	LSL 1215-25 WE	250 m	CHF 1.80/m
	LSL 1215-25 TR	250 m	CHF 1.80/m



Bezeichnung Désignation Definizione	Grösse Dimension Taglio	Vermassung Mesurage Misurazione	Preis Prix Prezzo
<b>Round-Line</b>	4 x 0.75 mm <sup>2</sup>	A=5.3 mm / B=5.3 mm / C=0.75 mm <sup>2</sup>	
	LRL 8475-1 WE	100 m	CHF 2.60/m



Bezeichnung Désignation Definizione	Grösse Dimension Taglio	Vermassung Mesurage Misurazione	Preis Prix Prezzo
<b>Mixed Silver</b>	2 x 1.5 mm <sup>2</sup> / 2 x 392 x 0.07 mm	A=3 mm / B=7.8 mm / C=1.5 mm <sup>2</sup>	
	LMS 5215-1 TR	100 m	CHF 11.00/m
	2 x 2.5 mm <sup>2</sup> / 2 x 651 x 0.07 mm	A=3.4 mm / B=8.8 mm / C=2.5 mm <sup>2</sup>	
	LMS 5225-1 TR	100 m	CHF 13.00/m
	2 x 4 mm <sup>2</sup> / 2 x 1050 x 0.07 mm	A=4.9 mm / B=9.6 mm / C=4 mm <sup>2</sup>	
	LMS 5245-1 TR	100 m	CHF 16.00/m

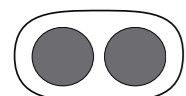

Bezeichnung Désignation Definizione	Grösse Dimension Taglio	Vermassung Mesurage Misurazione	Preis Prix Prezzo
<b>AC-Line</b>	2 x 0.75 mm <sup>2</sup>	A=3.5 mm / B=5.5 mm / C=0.75 mm <sup>2</sup>	
	TDLF 2x0,75 SW	100 m	CHF 1.40/m
	TDLF 2x0,75 WE	100 m	CHF 1.40/m
	TDLF 2x0,75 GO	100 m	CHF 1.40/m
	TDLR 2x0,75 TR	100 m	CHF 3.00/m
	3 x 0.75 mm <sup>2</sup>	A=6 mm / B=6 mm / C=0.75 mm <sup>2</sup>	
	TDLR 3x0,75 SW	100 m	CHF 1.80/m
	TDLR 3x0,75 WE	100 m	CHF 1.80/m
	TDLR 3x0,75 GO	100 m	CHF 1.80/m
	TDLR 3x0,75 TR	100 m	CHF 3.80/m



Bezeichnung Désignation Definizione	Grösse Dimension Taglio	Vermassung Mesurage Misurazione	Preis Prix Prezzo
<b>Hiflex-Line</b>	2 x 0.75 mm <sup>2</sup> / 2 x 90 x 0.1 mm	A=2.3 mm / B=4.9 mm / C=0.75 mm <sup>2</sup>	
	LHL 2275-2 SW	200 m	CHF 1.-/m
	LHL 2275-2 WE	200 m	CHF 1.-/m
	LHL 2275-2 TR	200 m	CHF 1.-/m
	2 x 1.5 mm <sup>2</sup> / 2 x 190 x 0.1 mm	A=3.2 mm / B=7 mm / C=1.5 mm <sup>2</sup>	
	LHL 2215-1 RS	100 m	CHF 2.20/m
	LHL 2215-1 WE	100 m	CHF 2.20/m
	LHL 2215-1 TR	100 m	CHF 2.20/m
	LHL 2215-2 WE	200 m	CHF 2.20/m
	LHL 2215-2 TR	200 m	CHF 2.20/m
	2 x 2.5 mm <sup>2</sup> / 2 x 315 x 0.1 mm	A=3.8 mm / B=8.8 mm / C=2.5 mm <sup>2</sup>	
	LHL 2225-1 RS	100 m	CHF 3.60/m
	LHL 2225-1 WE	100 m	CHF 3.60/m
	LHL 2225-1 TR	100 m	CHF 3.60/m
	2 x 4 mm <sup>2</sup> / 2 x 505 x 0.1 mm	A=4.4 mm / B=9.7 mm / C=4 mm <sup>2</sup>	
	LHL 2240-1 WE	100 m	CHF 6.00/m
	LHL 2240-1 TR	100 m	CHF 6.00/m
	2 x 6 mm <sup>2</sup> / 2 x 777 x 0.1 mm	A=4.7 mm / B=11.3 mm / C=6 mm <sup>2</sup>	
	LHL 2260-1 TR	100 m	CHF 9.50/m

Stromkabel/Câble électrique/Cavo elettrico

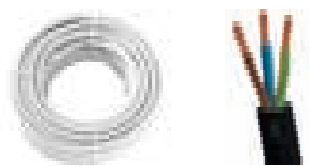

**Td-H05VV-F**  
Stromkabel 100 m  
Farben: weiss/schwarz  
3 x 1mm<sup>2</sup>: 139.–  
3 x 1,5mm<sup>2</sup>: 170.–

**Td-H05VV-F**  
Câble électrique 100 m  
Couleur: blanc/noir  
3 x 1mm<sup>2</sup>: 139.–  
3 x 1,5mm<sup>2</sup>: 170.–

**Td-H05VV-F**  
Cavo elettrico 100 m  
Colore: bianco/nero  
3 x 1mm<sup>2</sup>: 139.–  
3 x 1,5mm<sup>2</sup>: 170.–

Verlängerungskabel/Prolongateur/Prolunga



**Verlängerungskabel**  
3 x 1,5mm<sup>2</sup> – T12/T13  
Farbe: schwarz/weiss  
3m CHF 8.90  
5m CHF 10.80  
10m CHF 24.80

**Prolongateur**  
3 x 1,5mm<sup>2</sup> – T12/T13  
Couleur: noir/blanc  
3m CHF 8.90  
5m CHF 10.80  
10m CHF 24.80

**Prolunga**  
3 x 1,5mm<sup>2</sup> – T12/T13  
Colore: nero/bianco  
3m CHF 8.90  
5m CHF 10.80  
10m CHF 24.80

Kabelschläuche/Tuyau pour câbles/Tube porta-cavi

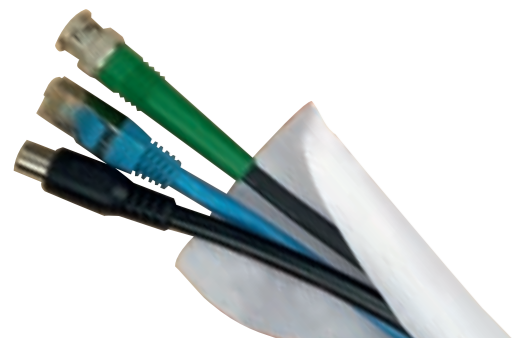

**WE**  
Weiss  
Blanc  
Blanco

**SW**  
Schwarz  
Noir  
Nero



Der beliebte Polyester-Kabelschlauch steht für Flexibilität, wenn es um Kabelmanagement geht. Er schliesst selber, ist wasch- und dehnbar.

Très apprécié, le tuyau pour câbles en polyester procure un maximum de flexibilité dans la gestion des câbles. Il se ferme tout seul et est lavable et étirable.

L'apprezzato manicotto passacavo in poliestere è garanzia di flessibilità nella gestione del cablaggio. Si chiude da solo, è lavabile ed espandibile.

2 m	Pro Blister Par unité Per blister	Preis Prix Prezzo	25 m	Pro Rolle Par bobine Per bobina	Preis Prix Prezzo
Ø 19 mm	KF 19mm-2m WE	CHF 31.–/VPE	Ø 19 mm	KF 19mm-25m WE	CHF 12.–/m
Ø 19 mm	KF 19mm-2m SW	CHF 31.–/VPE	Ø 19 mm	KF 19mm-25m SW	CHF 12.–/m
Ø 25 mm	KF 25mm-2m WE	CHF 39.–/VPE	Ø 25 mm	KF 25mm-25m WE	CHF 16.–/m
Ø 25 mm	KF 25mm-2m SW	CHF 39.–/VPE	Ø 25 mm	KF 25mm-25m SW	CHF 16.–/m
			Ø 38 mm	KF 38mm-25m SW	CHF 23.–/m

Kabelsocken/Gaines tressées passe-câbles/Calza cavo



**WE**  
Weiss  
Blanc  
Blanco

**SW**  
Schwarz  
Noir  
Nero

**GR**  
Silber  
Argent  
Argento



Der geschlossene und dehnbare Polyestersocken lässt sich einfach zuschneiden.

Fermée et expansible la gaine en polyester est facile à découper.

La guaina chiusa ed elastica in poliestere è facile da ritagliare.

10 m	Pro Rolle Par bobine Per bobina	Preis Prix Prezzo	50 m	Pro Rolle Par bobine Per bobina	Preis Prix Prezzo
Ø 20 mm (Max. 40 mm)	KS 20-10m WE	CHF 69.–	Ø 20 mm (Max. 40 mm)	KS 20-50m WE	CHF 220.–
Ø 20 mm (Max. 40 mm)	KS 20-10m SW	CHF 69.–	Ø 20 mm (Max. 40 mm)	KS 20-50m SW	CHF 220.–
Ø 20 mm (Max. 40 mm)	KS 20-10m GR	CHF 69.–	Ø 20 mm (Max. 40 mm)	KS 20-50m GR	CHF 220.–
Ø 40 mm (Max. 80 mm)	KS 40-10m WE	CHF 110.–	Ø 40 mm (Max. 80 mm)	KS 40-50m WE	CHF 448.–
Ø 40 mm (Max. 80 mm)	KS 40-10m SW	CHF 110.–	Ø 40 mm (Max. 80 mm)	KS 40-50m SW	CHF 448.–
Ø 40 mm (Max. 80 mm)	KS 40-10m GR	CHF 110.–	Ø 40 mm (Max. 80 mm)	KS 40-50m GR	CHF 448.–
Ø 55 mm (Max. 110 mm)	KS 55-10m WE	CHF 148.–	Ø 55 mm (Max. 110 mm)	KS 55-50m WE	CHF 598.–
Ø 55 mm (Max. 110 mm)	KS 55-10m SW	CHF 148.–	Ø 55 mm (Max. 110 mm)	KS 55-50m SW	CHF 598.–
Ø 55 mm (Max. 110 mm)	KS 55-10m GR	CHF 148.–	Ø 55 mm (Max. 110 mm)	KS 55-50m GR	CHF 598.–

Heisschneidegerät/Outil de coupe chaud/Coltello a caldo per taglio



**Heisschneidegerät  
für Kabelsocken**  
CHF 290.–

**Coltello a caldo per taglio**  
CHF 290.–

**Outil de coupe chaud**  
CHF 290.–



Kabelbinder und Zubehör

Attache cable et accessoires/Fascetta stringicavo e accessori

Bezeichnung Désignation Definizione	Grösse (LxB) Dimension (LxL) Taglio (LxL)	Silber Argent Argento	VPE Emball. Imball.	Preise Prix Prezzo
<b>Kabelbinder</b>	100 x 2.5 mm	CV100SL1	100	CHF 1.25
<b>Attache cable</b>	150 x 3.6 mm	CV150SL1	100	CHF 2.65
<b>Fascetta stringicavo</b>	200 x 2.5 mm	CV200MSL1	100	CHF 2.81
	200 x 4.6 mm	CV200SL1	100	CHF 4.52
	300 x 4.8 mm	CV300SSL1	100	CHF 7.80
	368 x 4.8 mm	CV368SL1	100	CHF 8.74
	368 x 3.6 mm	CV368SSL1	100	CHF 6.71

Bezeichnung Désignation Definizione	Grösse (LxB) Dimension (LxL) Taglio (LxL)	Natural/weiss Naturale/blanc Naturale/bianco	Schwarz Noir Nero	VPE Emball. Imball.	Preise Prix Prezzo
<b>Kabelbinder</b>	100 x 2.5 mm	CV100	CV100BK	100	CHF 0.78
<b>Attache cable</b>	140 x 2.5 mm	CV140S	CV140SBK	100	CHF 1.72
<b>Fascetta stringicavo</b>	165 x 2.5 mm	CV165	CV165BK	100	CHF 1.87
	200 x 2.5 mm	CV200M	CV200MBK	100	CHF 2.18
	150 x 3.6 mm	CV150	CV150BK	100	CHF 2.03
	200 x 3.6 mm	CV200A	CV200ABK	100	CHF 2.34
	292 x 3.6 mm	CV292	CV292BK	100	CHF 4.21
	368 x 3.6 mm	CV368S	CV368SBK	100	CHF 5.62
	200 x 4.6 mm	CV200	CV200BK	100	CHF 3.90
	250 x 4.8 mm	CV250	CV250BK	100	CHF 5.93
	280 x 4.8 mm	CV280	CV280BK	100	CHF 5.93
	300 x 4.8 mm	CV300S	CV300SBK	100	CHF 7.02
	368 x 4.8 mm	CV368	CV368BK	100	CHF 7.64
	385 x 4.8 mm	CV385	CV385BK	100	CHF 10.92
	300 x 7.6 mm	CV300	CV300BK	100	CHF 12.48
	380 x 7.6 mm	CV380	CV380BK	100	CHF 14.35
	450 x 8.0 mm	CV450	CV450BK	100	CHF 24.96
	550 x 9.0 mm	CV550	CV550BK	100	CHF 28.39
762 x 9.0 mm	CV762	CV762BK	100	CHF 39.78	
<b>Kabelbandhalter/Fixation attache/</b>	19.5 x 19.5 mm	HC101S-S2	HC101S-S2BK	100	CHF 10.76
<b>Fascetta supporto</b>	28.6 x 28.6 mm	HC102	HC102BK	100	CHF 15.44
<b>Markierkabelbinder</b>	100 x 2.5 mm	MCV100	MCVR100BK	100	CHF 4.68
<b>Attache marque</b>	110 x 2.5 mm	MCV110	MCVR110BK	100	CHF 5.62
<b>fascetta marcatura</b>	130 x 2.5 mm	MCV100L	MCVR100LBK	100	CHF 6.71
	200 x 2.5 mm	MCV200S	MCVR200SBK	100	CHF 7.64
<b>Kabelbinder wiederlösbar</b>	200 x 7.6 mm	HVC 200	HVCR200BK	100	CHF 17.-
<b>Attache réutilisable</b>	250 x 7.6 mm	HCV 250	HVCR250BK	100	CHF 20.12
<b>Fascetta ricidabile</b>	300 x 7.6 mm	HCV 300	HVCR300BK	100	CHF 23.24



Kabelkanäle/Chemins de câbles/Condotti per cavi

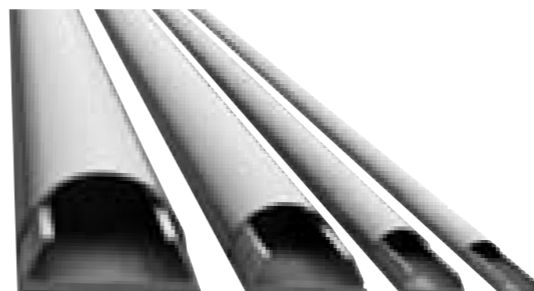

Aluminium/Aluminium/Alluminio

- WE Weiss  
Blanc  
Blanco
- SW Schwarz  
Noir  
Nero
- AL Silber  
Argent  
Argento



Die stabilen Alukanäle lassen in Bezug auf Farben, Grössen und Längen kaum Wünsche offen.

Les passe-câbles robustes en aluminium existent dans pratiquement tous les couleur, formats et longueurs.

Le robuste canaline in alluminio sono all'altezza di qualsiasi esigenza in quanto a colori, dimensioni e lunghezze.

1100 mm	Preis Prix Prezzo		1600 mm	Preis Prix Prezzo
12 mm KK 12-1100 WE	CHF 39.-		12 mm KK 12-1600 WE	CHF 55.-
12 mm KK 12-1100 SW	CHF 39.-		12 mm KK 12-1600 SW	CHF 55.-
12 mm KK 12-1100 AL	CHF 39.-		12 mm KK 12-1600 AL	CHF 55.-
18 mm KK 18-1100 WE	CHF 48.-		18 mm KK 18-1600 WE	CHF 59.-
18 mm KK 18-1100 SW	CHF 48.-		18 mm KK 18-1600 SW	CHF 59.-
18 mm KK 18-1100 AL	CHF 48.-		18 mm KK 18-1600 AL	CHF 59.-
33 mm KK 33-1100 WE	CHF 58.-		33 mm KK 33-1600 WE	CHF 78.-
33 mm KK 33-1100 SW	CHF 58.-		33 mm KK 33-1600 SW	CHF 78.-
33 mm KK 33-1100 AL	CHF 58.-		33 mm KK 33-1600 AL	CHF 78.-
50 mm KK 50-1100 WE	CHF 85.-		50 mm KK 50-1600 WE	CHF 109.-
50 mm KK 50-1100 SW	CHF 85.-		50 mm KK 50-1600 SW	CHF 109.-
50 mm KK 50-1100 AL	CHF 85.-		50 mm KK 50-1600 AL	CHF 109.-
75 mm KKS 75-1100 WE	CHF 109.-		75 mm KKS 75-1600 WE	CHF 149.-
75 mm KKS 75-1100 SW	CHF 109.-		75 mm KKS 75-1600 SW	CHF 149.-
75 mm KKS 75-1100 AL	CHF 109.-		75 mm KKS 75-1600 AL	CHF 149.-
33 mm KW 33-WE	CHF 59.-		50 mm KW 50-WE	CHF 65.-
33 mm KW 33-SW	CHF 59.-		50 mm KW 50-SW	CHF 65.-
33 mm KW 33-AL	CHF 59.-		50 mm KW 50-AL	CHF 65.-

## AGFA Batterien/piles/batterie

LR3 Micro	Blister 4 Stk./pcs./pezzi	Box: 12	CHF 6.90
LR6 Mignon	Blister 4 Stk./pcs./pezzi	Box: 12	CHF 6.90
LR14 Baby	Blister 2 Stk./pcs./pezzi	Box: 6	CHF 7.90
LR20 Mono	Blister 2 Stk./pcs./pezzi	Box: 6	CHF 7.90
LR61 9V	Blister 1 Stk./pcs./pezzi	Box: 12	CHF 7.90
LR6 Mignon	10 Stk./pcs./pezzi	Box: 20	CHF 9.90
LR3 Micro	10 Stk./pcs./pezzi	Box: 20	CHF 9.90
CR 123 A	Blister 1 Stk./pcs./pezzi	Box: 12	CHF 7.90
CR 2	Blister 1 Stk./pcs./pezzi	Box: 12	CHF 7.90
CR2016 3V	Blister 1 Stk./pcs./pezzi	Box: 12	CHF 3.90
CR2025 3V	Blister 1 Stk./pcs./pezzi	Box: 12	CHF 3.90
CR2032 3V	Blister 1 Stk./pcs./pezzi	Box: 12	CHF 3.90
CR2450 3V	Blister 1 Stk./pcs./pezzi	Box: 12	CHF 3.90
CR1620 3V	Blister 1 Stk./pcs./pezzi	Box: 12	CHF 3.90
CR1220 3V	Blister 1 Stk./pcs./pezzi	Box: 12	CHF 3.90
LR44 (GA13)	Blister 1 Stk./pcs./pezzi	Box: 12	CHF 3.90



## AGFA Akkus/accumulateurs/accumulatori

LR3 Micro 900	Blister 2 Stk./pcs./pezzi	Box: 12	CHF 7.90
LR3 Micro 900	Blister 4 Stk./pcs./pezzi	Box: 12	CHF 13.90
LR6 Mignon 2300	Blister 2 Stk./pcs./pezzi	Box: 12	CHF 13.90
LR6 Mignon 2300	Blister 4 Stk./pcs./pezzi	Box: 12	CHF 19.90



## Allgemeine Lieferungs- und Zahlungsbedingungen

### 1. Preise

Unsere Preise verstehen sich rein netto in CHF, ohne Mehrwertsteuer. Zur Anwendung kommen die im Katalog zur Zeit gültigen Listenpreise. Diese können jederzeit, ohne vorherige Mitteilung, geändert werden.

### 2. Zahlungskonditionen

Unsere Preise verstehen sich netto bei Zahlung innert 30 Tagen. Ungerechtfertigte Abzüge werden nachbelastet. Nach Ablauf der Zahlungsfrist tritt Verzug ein. Liquidations- oder Spezialangebote können speziellen Zahlungskonditionen unterliegen. Die Ware bleibt bis zur vollständigen Bezahlung unser Eigentum.

### 3. Versand und Verpackung

Sämtliche Lieferungen erfolgen auf Rechnung und Gefahr des Empfängers. Porto, Verpackung und Expresskosten werden zu Selbstkosten verrechnet.

### 4. Beanstandungen

Beanstandungen sind innerhalb 2 Tagen nach Ankunft der Ware anzubringen, andernfalls gilt die Lieferung als genehmigt. Wir übernehmen keine Haftung für Verlust, Bruch oder Beschädigungen auf dem Transport. Schäden oder Verluste sind sofort dem Transporteur zu melden. Es ist ein Protokoll zu verlangen.

### 5. Retoursendungen

Retoursendungen werden nur mit unserem Einverständnis zurückgenommen. Wenn uns keine Schuld trifft, wird die Gutschrift um mindestens 10%, je nach Zustand der Ware, für Umtriebe gekürzt. Auslaufartikel oder Spezialangebote werden nicht zurückgenommen. Die retournierten Artikel müssen in einwandfreiem, verkaufsfertigem Zustand sein. Die Originalverpackung muss beigelegt sein.

### 6. Lieferfrist

Die Lieferung erfolgt im allgemeinen sofort ab Lager. Die angegebenen Liefertermine sind unverbindlich. Für nicht ausgeführte oder verspätete Lieferungen werden sämtliche Schadenersatzansprüche abgelehnt.

### 7. Garantie

Die Garantiezeit beträgt 2 Jahre nach Kauf.

### 8. Masse, Gewichte, Abbildungen

Sämtliche in Katalogen und Preislisten angegebenen Masse, Gewichte, Angaben und Abbildungen sind unverbindlich. Sie können von uns jederzeit geändert werden.

### 9. Gerichtsstand

Erfüllungsort und Gerichtsstand ist 8853 Lachen SZ.

## Conditions générales de livraison et de paiement

### 1. Prix

Nos prix s'entendent nets, en CHF, T.V.A. non compris. Ce sont les prix de la liste en vigueur au moment de la livraison qui font foi. Ils peuvent être modifiés en tous temps sans avertissement.

### 2. Conditions de paiement

Nos prix s'entendent net à 30 jours. Nous accordons 3% d'escompte pour paiement dans les 8 jours. Ces escomptes seront aussi déduits lors des livraisons contre remboursement. Les déductions non justifiées seront facturées en sus. Après expiration inutilisée du délai de paiement, l'acheteur est en retard. Des conditions de paiement spéciales peuvent être fixées pour des offres d'actions où de liquidations. La marchandise reste à disposition du vendeur jusqu'au paiement total de la contrepartie.

### 3. Emballage, expédition

Toutes les livraisons sont aux risques et périls du destinataire. Les frais d'expédition et d'emballage seront facturés au prix de revient. Pour les envois par express, un supplément sera facturé.

### 4. Réclamations

Les réclamations doivent être faites dans les 2 jours après réception de la marchandise. Si non, la livraison sera supposée être arrivée en bon état. Nous n'assumons aucune responsabilité en cas de perte, de casse ou de dommages en cours de transport. Les dommages et les pertes doivent être annoncés immédiatement à l'entreprise de transport et font l'objet d'un procès verbal.

### 5. Retours

Les retours ne sont acceptés qu'avec notre accord. S'il n'y a pas faute de notre part, la bonification sera réduite ou moins de 10% en raison des faux-frais. La marchandise renvoyée doit être dans un état impeccable. L'emballage original doit être joint.

### 6. Délai de livraison

Les livraisons se font normalement directement du stock. Les délais de livraison indiqués s'entendent sans engagement de notre part. Pour des livraisons retardées ou inexécutées, nous déclinons toutes demandes de dédommagements.

### 7. Garantie

Le temps de garantie se monte 2 ans après l'achat.

### 8. Mesures, poids, illustrations

Les mesures, poids, indications et illustrations contenus dans nos catalogues et prix courant se comprennent sans engagement de notre part et peuvent être modifiés à tout moment.

### 9. Lieu de juridiction

Le lieu d'exécution et le for sont à 8853 Lachen SZ.

